

# ZANUSSI



FRIDGE - FREEZER

ZRD 7846

INSTRUCTION BOOK

GB

**This instruction book contains safety precautions, information on use and helpful hints and tips.**

**To ensure you use this appliance effectively and safely, please read this instruction book carefully before installing or using this appliance and retain for future reference.**

The symbols below help you to find things more easily:



**Safety precautions**

Warnings and Safety information



**Hints, useful information**



**Environmental information**



The symbol on the product or on its packaging indicates that this product may not be treated as household waste. Instead it shall be handed over to the applicable collection point for the recycling of electrical and electronic equipment. By ensuring this product is disposed of correctly, you will help prevent potential negative consequences for the environment and human health, which could otherwise be caused by inappropriate waste handling of this product. For more detailed information about recycling of this product, please contact your local city office, your household waste disposal service or the shop where you purchased the product.

# IMPORTANT SAFETY INSTRUCTIONS

These warnings are provided in the interests of your safety. Ensure that you understand them all before installing or using this appliance. Your safety is of paramount importance. If you are unsure about any of the meanings or these warnings contact the Customer Care Department.

## Prior to installation

- Check the appliance for transport damage. Under no circumstances should a damaged appliance be installed. In the event of damage please contact your retailer.

## Installation

- This appliance is heavy. Care should be taken when moving it.
- It is dangerous to alter the specifications or attempt to modify this product in any way.
- Ensure that the appliance does not stand on the electrical supply cable. If the supply cable is damaged, it must be replaced by a cable available from your local Service Force Centre.
- **Make sure that the power plug is not squashed or damage the back of the fridge/freezer.**
  - A damaged power plug may overheat and cause a fire.
- **Do not place heavy articles or the fridge/freezer itself on the power cord.**
  - There is a risk of a short circuit and fire.
- **Do not remove the power cord by pulling on its lead, particularly when the fridge/freezer is being pulled out of its niche.**
  - Damage to the cord may cause a short-circuit, fire and/or electric shock.
  - If the power cord is damaged, it must be replaced by a certified service agent or qualified service personnel.
- **If the power plug socket is loose, do not insert the power plug.**
  - There is a risk of electric shock or fire.
- Any electrical work required to install this appliance should be carried out by a qualified electrician or competent person.
- Parts which heat up should not be exposed. Whenever possible, the back of the appliance should be close to a wall, but leaving the required distance for ventilation, as stated in the installation instructions.
- The appliance should be left for 2 hours after installation before it is turned on, in order to allow the refrigerant to settle.

## Child Safety

- Do not allow children to tamper with the controls or play with the product.
- There is a risk of suffocation! Keep packaging material away from children!

## Safety precautions for isobutane

### Warning

- The refrigerant isobutane (R 600a) is contained within the refrigerant circuit of the appliance, a natural gas with a high level of environmental compatibility, which is nevertheless flammable.
- Keep ventilation openings, in the appliance enclosure or in the built-in structure, clear of obstruction.
- Do not use mechanical devices or other means to accelerate the defrosting process, other than those recommended by the manufacturer.

- Do not damage the refrigerant circuit.
- Do not use electrical appliances inside the food storage compartments of the appliance.

## During Use

- This appliance is designed for domestic use only, specifically for the storage of edible foodstuffs. It is not intended for commercial or industrial use.
- Containers with flammable gases or liquids can leak at low temperatures. Do not store any containers with flammable materials, such as spray cans, fire extinguisher refill cartridges etc. in the appliance.
- Frozen food should not be refrozen once it has thawed out.
- Do not place carbonated or fizzy drinks in the freezer compartment.
- Ice lollies can cause 'frost/freezer burns' if consumed straight from the freezer.
- Do not remove items from the freezer compartment if your hands are damp/wet, as this could cause skin abrasions or frost/freezer burns.
- Bottles and cans must not be placed in the freezer compartment they can burst when the contents freeze.
- Manufacturers' recommended storage times should be adhered to. Refer to relevant instructions.

## Maintenance and Cleaning

- Before cleaning, always switch off the appliance and disconnect from the electrical supply.
- When unplugging always pull the plug from the mains socket, do not pull on the cable.

## Servicing

- This product should be serviced by an authorised engineer and only genuine spare parts should be used.
- Under no circumstances should you attempt to repair the appliance yourself. Repairs carried out by inexperienced persons may cause injury or serious malfunctioning. Contact your local Service Force Centre.

## At the end of the Appliance Life

- When disposing of your appliance use an authorised disposal site.
- Remove the plug and ensure that any locks or catches are removed, to prevent young children being trapped inside.



## The Appliance and the Environment

This appliance does not contain gases which could damage the ozone layer.

Avoid damaging the cooling unit.

The packaging used on this appliance marked with the  symbol is recyclable.

**Keep this instruction book for future reference and ensure it is passed on to any new owner.**

# CONTENTS

## Instructions for the User

<b>Important Safety Instructions</b>	<b>3</b>
General Information	5
Description of the Appliance	5
<b>Using the Appliance</b>	<b>6</b>
Before Use	6
To Start the Appliance	6
Temperature Control	6
The Refrigerator	7
Storage Shelves	7
Storage Times	7
Freezing Fresh Food	8
Frozen Food Storage	8
Thawing	8
To Make Ice Cubes	8
<b>Hints and Tips</b>	<b>9</b>
Normal Operating Sounds	9
Food Storage	9
Energy Saving Advice	9
In the Event of a Power Failure	9
<b>Maintenance and Cleaning</b>	<b>10</b>
Internal Cleaning	10
External Cleaning	10
When the Appliance is Not in Use	10
<b>Defrosting</b>	<b>10</b>
Refrigerator	10
Freezer	11
<b>To Change the Light Bulb</b>	<b>11</b>
<b>Something Not Working</b>	<b>12</b>
<b>Service and Spare Parts</b>	<b>13</b>
<b>Customer Care Department</b>	<b>13</b>
<b>Guarantee Conditions</b>	<b>14</b>

## Instructions for the Installer

<b>Technical Data</b>	<b>15</b>
<b>Installing the Appliance</b>	<b>15</b>
Transportation, Unpacking	15
Cleaning	15
Location	15
Levelling the Appliance	16
Ventilation Requirements	16
Door Reversal	17
<b>Electrical Connections</b>	<b>18</b>
<b>Storage Chart</b>	<b>19</b>

# INSTRUCTIONS FOR THE USER

## General information

This appliance is designed for the storage of refrigerated and frozen food in a domestic environment.

To ensure correct operation, the appliance should be located where the ambient temperature is between 10-32 °C.

## Description of the appliance

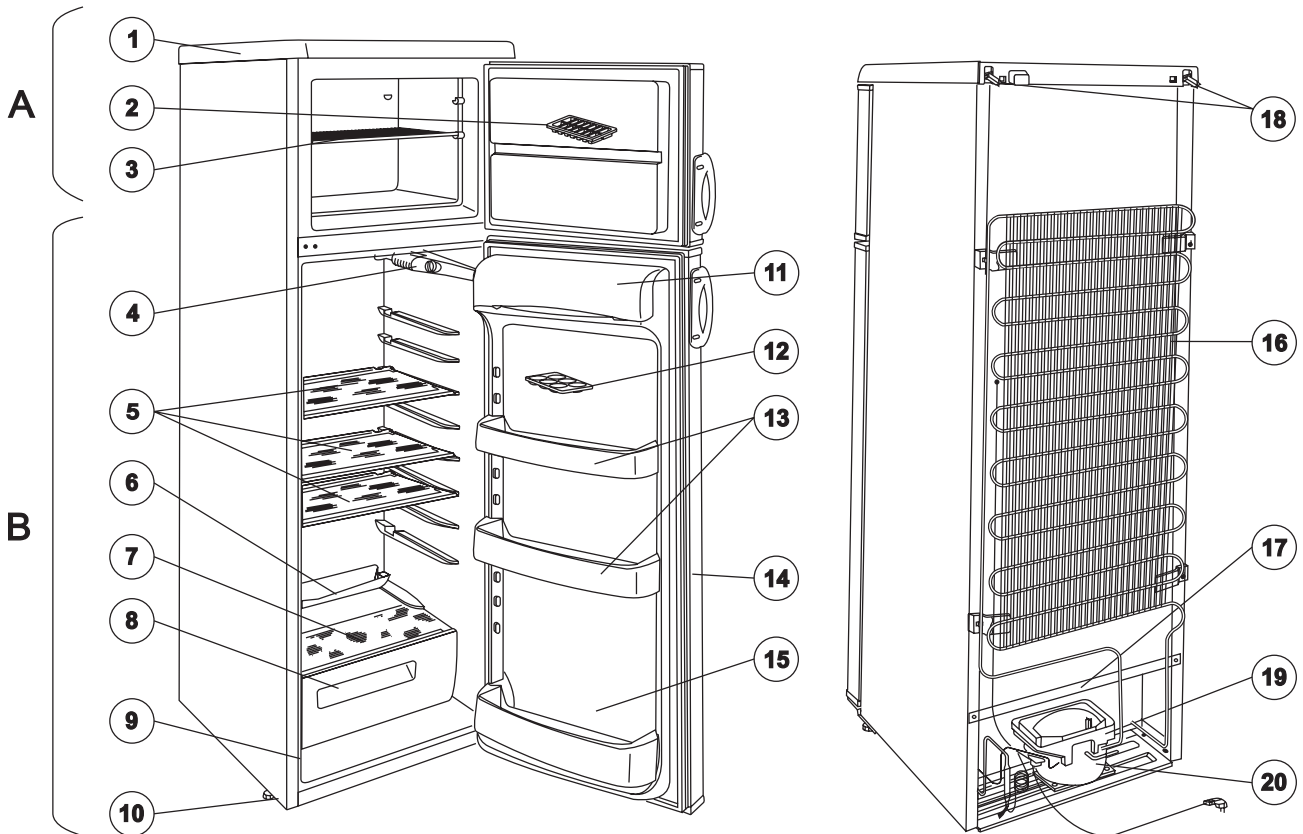

A - Freezer

B - Refrigerator

1. Top Panel

2. Ice tray

3. Wire shelf in the Freezer

4. Thermostat control/light

5. Glass shelves

6. Defrost water drain

7. Glass shelf

8. Salad drawer

9. Rating plate

10. Adjustable feet

11. Dairy compartment

12. Egg tray

13. Door shelf

14. Door gasket

15. Bottle shelf

16. Condenser

17. Defrost water outlet

18. Spacer

19. Evaporator tray

20. Compressor

## Using the Appliance



*This appliance is designed for domestic use only, specifically for the storage of edible foodstuffs.*

The appliance is designed to operate in ambient temperatures (surrounding air temperature) between 10 °C and 32 °C.

If these temperatures are exceeded i.e. colder or warmer, the appliance will not operate correctly. Should the ambient temperatures be exceeded for long periods, the temperature in the freezer section will rise above -18 °C and food spoilage may occur.

### Before Use

Remove all packaging and securing tapes. Wash inside the appliance with lukewarm water and bicarbonate of soda (5 ml to 0,5 litre of water). Do not use soap or detergent as the smell may linger. Dry thoroughly.



*Do not use detergents, abrasive powders, highly perfumed cleaning products, wax polishes or products containing alcohol.*



### To Start the Appliance

1. Allow the appliance to stand for 2 hrs after installation.
2. Plug in the appliance and switch on at the mains supply.
3. Turn the thermostat control to the required setting. A setting of 3 - 4 is usually suitable for normal operation (see thermostat control).
4. Leave the appliance for approximately 2 hours for the correct temperature to be reached before placing food inside.

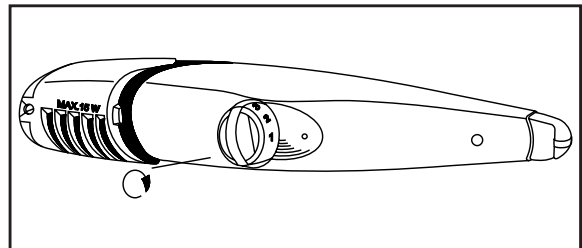

## Temperature Control

### The Refrigerator

The thermostat control situated inside the fridge compartment regulates the temperature of the fridge. The thermostat control is marked from 1-5, the higher the number, the colder the setting.

Position 0 - Off

Position 1 - minimum coldness

Position 6 - maximum coldness

The temperature will be affected by:

- Ambient temperature
- How often the door is opened
- How much food is stored
- Position of the appliance

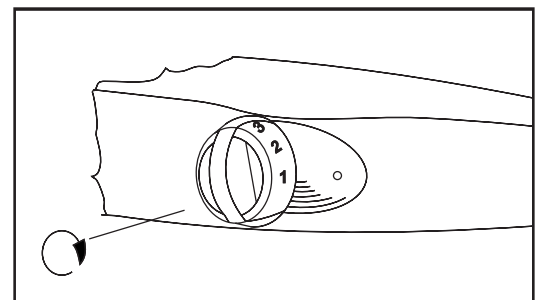

In determining the correct temperature control setting, all these factors have to be considered and some experimentation may be necessary.

 *Do not allow children to tamper with the controls or play with the product.*

## The Refrigerator

Below is the recommended storage positions for various food types:

1. Ready-cooked foods, fresh meat, cold cuts.
2. Milk, dairy products.
3. Fruits, vegetables, salads.
4. Cheese, butter.
5. Eggs.
6. Yoghurt, sour cream.
7. Small bottles, drinks.
8. Large bottles, drinks.

## Storage Shelves

The shelves in the refrigerator compartment are adjustable to allow for the storage of large items.

To re-arrange the shelves, open the door to 90°.

## Storage Times

The storage chart at the end of the instruction book gives information on storage times in the refrigerator compartment. The storage times quoted are intended as a guide only.

- Do not cover the shelves with paper or trays etc. as this will affect the air circulation within the refrigerator compartment.
- Do not put hot foods in the refrigerator, allow hot foods to reach room temperature naturally before placing in the refrigerator.
- Cover foods, or place in closed dishes before placing them in the refrigerator, this prevents any transference of food smells.

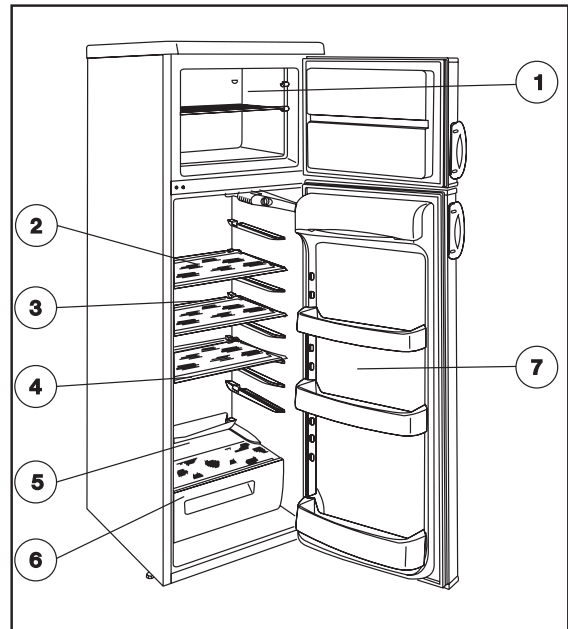

## The Freezer

### Freezing fresh food

In the compartment various fresh food can be frozen at home. Mind the following to get thorough result.

Freeze fresh and faultless food only.

Before starting freezing set the thermostatic control knob to position „3” and put the wire shelf in the frozen food compartment to the highest position. Then put in the quantity to be frozen, directly on the wire shelf. Freezing is completed in approx. 24 hours. After 24 hours set the thermostatic control knob back to „Medium” (2-3) position, or leave that in position „3” which is usually adequate for everyday use. It is practical to store the frozen food on the cooling plate or on each other under the wire shelf in the frozen food compartment.

 Avoid opening the door of frozen food compartment during freezing if possible.

 It is not expedient to set the thermostat knob to higher (e.g. „6”) position. Freezing time could be reduced this way, but the temperature of the fresh food compartment would go beyond 0 °C permanently, which would cause freezing to foods and drinks stored there.

 **Never freeze food in bigger quantity than given in the „Technical data” at the same time, otherwise freezing will not be thorough and after dissolving various deterioration may take place (losing taste and aroma, lysing, etc.).**

 Do not make ice during freezing preferably, because making ice reduces freezing capacity.

### Frozen Food Storage

When first starting the freezer or if the freezer has been out of use for some time, we advise you to run your appliance for at least 2 hours before storing frozen food.

Do not exceed the storage period indicated by the manufacturer.

Do not open the door frequently or leave it open longer than is necessary.

 **Important**

*Do not put carbonated liquids in the freezer.*

*Ice lollies, if consumed immediately after removal from the freezer can cause a low temperature skin burn.*

*In the event of a power cut the food in the freezer will not be affected if the power cut is short and the freezer is full. Do not open the door. Should the food begin to thaw it must be consumed quickly and must not be re-frozen. (See Hints and Tips)*

*Do not remove items from the freezer if your hands are damp/wet, as this could cause skin abrasions or frost/freezer burns.*

### Thawing

Deep frozen or frozen food, prior to being used, can be thawed in the fridge or at room temperature, depending on the time available. Small food items may even be cooked from frozen, in this case cooking will take longer.

Any frozen food which is allowed to thaw accidentally should either be eaten as soon as possible, or thrown away. Alternatively, if the food is uncooked and has not been completely defrosted it can be cooked and then refrozen.

 **Defrosted cooked food must never be refrozen.**

### To Make Ice Cubes

1. Fill the ice cube tray  $\frac{3}{4}$  full with cold water, place in the freezing compartment and leave to freeze.
2. To remove the cubes twist the tray or hold it under running water for a few seconds.

 **Never try to free an ice tray that is frozen to the freezer compartment by using pointed or sharp edged objects.**



# Hints & Tips

## Normal Operating Sounds

- You may hear faint gurgling or bubbling sounds when the refrigerant is pumped through the coils or tubing.
- When the compressor is on, the refrigerant is being pumped round and you will hear a whirring sound or pulsating noise from the compressor.
- A thermostat controls the compressor and you will hear a faint 'click' when the thermostat cuts in and out.

## Food Storage

To obtain the best performance from your freezer:

- Do not store warm food or evaporating liquid.
- Avoid buying frozen food if you cannot store it straight away. The use of an insulated container is advisable. When you arrive home, place the frozen food in the freezer immediately.
- Do not push food together too much, try to allow air to circulate around each item.
- Do not store food uncovered.
- Ensure that food placed in the freezer is dated and labelled and used in date order to ensure that food is consumed at its best.
- Lean food keeps better and longer than fatty food, salt reduces the storage time.
- Wrap the food in polythene or aluminium freezing bags or foil so that they adhere to the food and provide an airtight seal.
- Packaging which is swollen or has traces of refrozen water droplets on the pack could indicate that the product has not been kept at a suitable temperature and that it may have lost its original quality. Partially thawed food must not be refrozen, it must be consumed within 24 hours. Never exceed the storage times indicated by the manufacturer.

## Energy Saving Advice

- Do not install the appliance close to sources of heat, such as a boiler or radiator.
- Locate the appliance in a cool well ventilated room and make sure that the air openings of the appliance are not obstructed.
- Avoid unnecessary frosting in the cabinet by packing all foodstuffs into airtight packages before placing them in the freezer.
- Food which is to be frozen (when cool) should be placed in the fridge before being transferred to the freezer.
- Try to avoid keeping the door open for long periods or opening the door too frequently as warm air will enter the cabinet and cause the compressor to switch on unnecessarily often.
- Ensure there are no obstructions preventing the door from closing properly.

## In the Event of a Power Failure

If there is a power failure during the storage of frozen foods, keep the door closed. If the temperature within your freezer should rise, do not refreeze the food without checking its condition. The following guidelines should assist you:

**Ice Cream:** Once thawed should be discarded.

**Fruits & Vegetables:** If soft should be cooked and used up.

**Breads & Cakes:** Can be refrozen without danger.

**Shellfish:** Should be refrigerated and used up quickly.

**Cooked Dishes:** i.e. casseroles should be refrigerated and used up.

**Large Pieces of Meat:** Can be refrozen providing there are still ice crystals remaining within them.

**Small Joints:** Should be cooked and can then be refrozen as cooked dishes.

**Chicken:** Should also be cooked and refrozen as a fresh dish.

# Maintenance and Cleaning

 Before any maintenance or cleaning is carried out you must **DISCONNECT** the appliance from the electricity supply.

## Internal Cleaning

Clean the inside and accessories with warm water and bicarbonate of soda (5 ml to 0.5 litre of water).

Rinse and dry thoroughly.

 **NEVER use detergents, abrasive powders, highly perfumed cleaning products or wax polishes to clean the interior as these will damage the surface and leave a strong odour.**

## External Cleaning

Wash the outer cabinet with warm soapy water.

Once or twice a year dust the condenser (black grille) and the compressor at the back of the appliance with a brush or vacuum cleaner, as an accumulation of dust will affect the performance of the appliance and cause excessive electricity consumption.

## When the Appliance is not in Use

When the appliance is not in use for long periods, disconnect from the electricity supply, empty all foods and clean the appliance, leaving the door open to prevent unpleasant smells.

## Defrosting

### Refrigerator

The refrigerator defrosts every time the compressor stops. The water is discharged, via the pipe, into a tray located at the back of the appliance above the compressor, where it evaporates.

 **Important**

To avoid defrost water overflowing into the fridge, periodically clean the water discharge hole in the centre of the V shaped drip collector at the back of the refrigerator compartment, behind the salad drawers.

Use a piece of flexible curtain wire for this purpose.

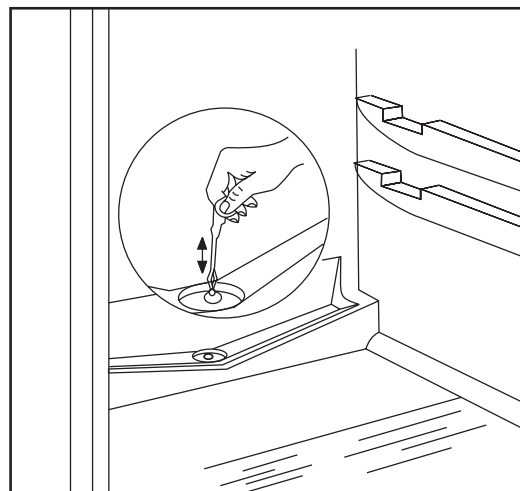

## Freezer

The freezer compartment will become progressively covered with frost. This should be removed with the special plastic scraper provided, whenever the thickness of the frost reaches 6 mm (¼").

During this operation it is not necessary to switch of the power supply or to remove the foodstuffs.

However, when the ice becomes very thick on the inner liner, complete defrosting should be carried out and it is advisable to perform this operation when the appliance is empty.

For complete defrosting (once or twice a year) proceed as follows:

1. Disconnect the appliance from the mains.
2. Remove any food from inside the freezer, wrap it in several sheets of newspaper and store in a cool, dry place. Ensure that the fridge door is not opened to protect the food in the refrigerator while defrosting the freezer.
3. When defrosting is complete, dry the interior thoroughly.
4. Reconnect the appliance to the mains, set the thermostat control knob to the maximum setting. Leave the appliance to run for at least two hours.
5. Replace the previously removed food.
6. Return the thermostat control knob to a medium setting.

### Important

*A temperature rise of the frozen food packs during defrosting may shorten their safe storage life.*

*Never use sharp metal tools to scrape off frost from the evaporator as this could damage the appliance beyond repair.*

### To Change the Light Bulb

1. Disconnect the appliance from the electrical supply.
2. Remove the lamp cover securing screw.
3. Take the lamp cover off in the direction of the arrow and change the bulb. (Type of bulb: 230 V, 15 W, E 14 thread)
4. Replace the lamp cover and fixing screw.

Spare bulbs are available from your local Service Force Centre.

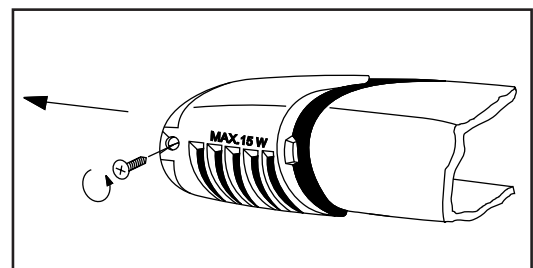

# Something Not Working

If the appliance is not working correctly, please carry out the following checks before contacting your local Service Force Centre.

Problem	Possible Cause	Solution
No power to the appliance	No power at the socket. There is a power cut.  The fuse has blown. Thermostat control knob is set at „0“.	Check there is power at the socket. Check there is not a power cut by checking the household lights. Check the fuse has not blown. Check the thermostat setting.
The temperature in the fridge or freezer is too high	The appliance is located in an unsuitable position. The thermostat control knob is set too low.	Check the ambient temperature is within the appliances operating limits of 10 °C to 32 °C. Check that the thermostat control knob is turned to the correct setting relative to ambient conditions.
The compressor runs continuously	The thermostat control knob is set at the wrong temperature. The door is open. Large quantities of food have been placed in the cabinet. The door has been opened too frequently. The air ventilation is obstructed.	Adjust the thermostat control knob.  Close the door.  Do not leave the door open longer than necessary. Check that the air ventilation is not obstructed.
The temperature in the fridge or freezer is too low	The thermostat control knob is set too cold.	Set the thermostat control knob to a warmer position.
Excessive frost and ice has built up	The door has been left open. Something is obstructing the door. The door gasket is dirty.	Check the door has not been left open. Check nothing is preventing the door from closing. Check the door gasket is intact and clean.
The appliance is noisy.	The appliance is not level.	Check if the appliance stands stable on the floor.

If after the above checks your appliance still does not operate correctly, contact your local Service Force Centre.

Please note that it will be necessary to provide proof of purchase for any in-guarantee service calls.

**In-guarantee customers should ensure that the above checks have been made, as the engineer will make a charge if the fault is not a mechanical or electrical breakdown.**

## Service and Spare Parts

In the event of your appliance requiring service, or if you wish to purchase spare parts, please contact your local Service Force Centre by telephoning:-

**08705 929929**

Your telephone call will be automatically routed to the Service Force Centre covering your post code area.

For the address of your local Service Force Centre and further information about Service Force, please visit the website at [www.serviceforce.co.uk](http://www.serviceforce.co.uk)

Before calling out an engineer, please ensure you have read the details under the heading "Something Not Working."

When you contact the Service Force Centre you will need to give the following details:

1. Your name, address and post code
2. Your telephone number
3. Clear and concise details of the fault
4. The model and serial number of the appliance (found on the rating plate)
5. The purchase date

**Please note that a valid purchase receipt or guarantee documentation is required for in-guarantee service calls.**

For Customer Service in Ireland please contact us at the address below:

Zanussi - Electrolux  
Electrolux Group (Irl) Ltd  
Long Mile Road  
Dublin 12  
Republic of Ireland

Tel: +353 (0)1 4090751

Email: [service.eid@electrolux.ie](mailto:service.eid@electrolux.ie)

## Customer Care Department

For general enquiries concerning your Zanussi - Electrolux appliance or for further information on Zanussi - Electrolux products, please contact our Customer Care Department by letter or telephone at the addresses below or visit our website at [www.zanussi-electrolux.co.uk](http://www.zanussi-electrolux.co.uk)

Customer Care Department

Zanussi - Electrolux  
55-77 High Street  
Slough  
Berkshire  
SL1 1DZ

08705 727727 (\*)

\*calls to this number may be recorded for training purposes.

# Guarantee Conditions

We Zanussi - Electrolux undertake that if within 12 months of the date of the purchase this ZANUSSI - ELECTROLUX appliance or any part thereof is proved to be defective by reason only of faulty workmanship or materials, the company will, at our option repair or replace the same FREE OF CHARGE for labour, materials or carriage on condition that:

- The appliance has been correctly installed and used only on the electrical supply stated on the rating plate.
- The appliance has been used for normal domestic purposes only, and in accordance with the manufacturer's instructions.
- The appliance has not been serviced, maintained, repaired, taken apart or tampered with by any person not authorised by us.
- All service work under this guarantee must be undertaken by a Service Force Centre.
- Any appliance or defective part replaced shall become the Company's property.

Home visits are made between **8.30am** and **5.30pm Monday to Friday**. Visits may be available outside these hours in which case a premium will be charged.

## EXCLUSIONS

### This Guarantee does not cover:

Damage or calls resulting from transportation, improper use or neglect, the replacement of any light bulbs or removable parts of glass or plastic.

- Costs incurred for calls to put right an appliance improperly installed or calls to appliances outside the United Kingdom.
- Appliances found to be in use within a commercial environment, plus those which are the subject of rental agreements.
- Products of Zanussi - Electrolux manufacture which are not marketed by Zanussi - Electrolux.

The guarantee is in addition to your statutory and legal rights.

## EUROPEAN GUARANTEE

If you should move to another country within Europe then your guarantee moves with you to your new home subject to the following qualifications:

- The guarantee starts from the date you first purchased your product.
- The guarantee is for the same period and to the same extent for labour and parts as exists in the new country of use for this brand or range of products.
- This guarantee relates to you and cannot be transferred to another user.
- Your new home is within the European Community (EC) or European Free Trade Area.
- The product is installed and used in accordance with our instructions and is only used domestically, i.e. a normal household.
- The product is installed taking into account regulations in your new country.

Before you move please contact your nearest Customer Care Centre, listed below, to give them details of your new home. They will then ensure that the local Service Organisation is aware of your move and able to look after you and your appliances.

France	Senlis	+33 (0) 344 62 29 29
Germany	Nuremberg	+49 (0) 800 234 7378
Italy	Pordenone	+39 (0) 0434 39 4700
Sweden	Stockholm	+46 (0) 8 672 53 90
UK	Slough	+44 (0) 1753 219897
Ireland	Dublin	+353 (0)1 4090751

# Instructions for the Installer

## Technical data

Model	ZRD 7846
Gross capacity (l)	Freezer: 50 Refrigerator: 220
Net capacity (l)	Freezer: 50 Refrigerator: 217
Width (mm)	545
Height (mm)	1590
Depth (mm)	604
Energy consumption (kWh/24h) (kWh/year)	0,82 299
Energy class, according to EU standards	A
Freezing capacity (kg/24h)	4
Rising time (h)	20
Rated power (W)	90
Weight (kg)	55
Number of compressors	1

## Installing the appliance

### Transportation, unpacking

The appliance and the interior fittings are protected for transport.

- Remove all packaging and any adhesive tape.
- Any remnants of adhesive can be removed using white spirit.
- After transportation the appliance must not be switched on for 2 hours. This is to allow the refrigerant to settle.

### Cleaning

Clean the accessories and the inside of the appliance with warm water and bicarbonate of soda (5 ml to 0.5 litres of water). Rinse and dry thoroughly.

*Do not use detergents, abrasive powders, highly perfumed cleaning products, wax polishes or cleaning products containing bleach or alcohol.*

## Location

The appliance should be positioned in a well ventilated, dry room.

Energy use is affected by the ambient temperature.

The appliance should therefore:

- not be installed next to radiators, cookers or other sources of heat
- only be installed at a location where the ambient temperature corresponds to the climate classification, for which the appliance is designed.

The climate classification can be found on the rating plate.

The following table shows which ambient temperature is correct for each climate classification:

Climate Classification	Ambient Temperature
SN	+10 to +32 °C
N	+16 to +32 °C
ST	+18 to +38 °C

## Levelling the Appliance

When placing the appliance ensure that it stands level. This can be achieved by adjusting either or both of the feet (1) at the front of the appliance. If required the washers (2), that are accessories of the feet, can be removed.

Do not stand the appliance next to a source of heat such as a radiator or cooker.

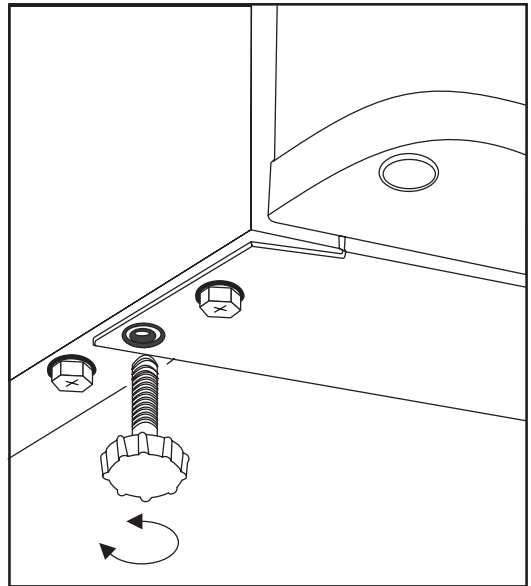

The plastic bag of accessories also contains two spacers to be fitted into special holes in the back of the appliance. Fit the spacers into the holes, taking care to ensure that the arrow (A) is positioned as shown in Figure. Then turn them through 45° (arrow (A) vertical) until they lock into place.

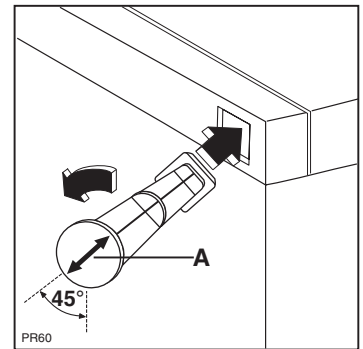

## Ventilation Requirements

The appliance must have adequate ventilation to ensure correct operation.

Diagram shows the ventilation requirements when installed:

- A Under a cupboard.
- B When freestanding

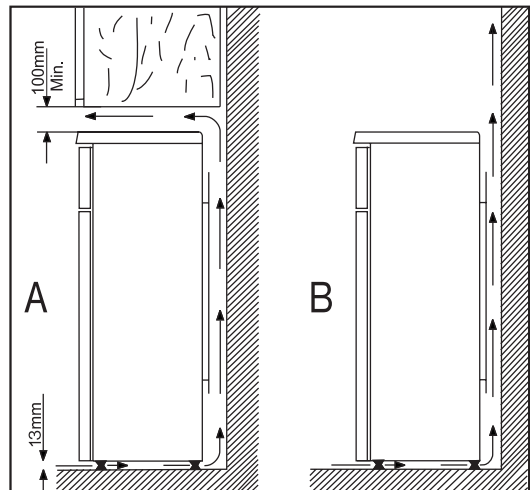



## Door Reversal

- Disconnect the appliance from the electricity supply.
- Tilt back the appliance carefully. It is recommended to ask another person for help, who can keep the appliance at this position safely.
- Unscrew on the both sides adjustable feet (2 pieces) and the fixing screws (2 pieces) of bottom door holder and the far side screws (2 pieces) too.
- Take off the door of the refrigerator by pulling it slightly downwards.
- Dismount the double door holder by removing the screws (2 pieces).
- Take off the door of the freezer by pulling it slightly downwards.
- Unscrew the top door holding pin of the freezer, then screw it back on the other side.
- Remove the covering nails of the double door holder on the left side and put them to the other side.
- Fit the door of the freezer to the top door holding pin.
- Fix the double door holder onto the left side using the screws (2 pieces). Be careful that the door edge of the freezer is parallel with the edge of the mantle.
- Fit the door of the refrigerator to the double door holder pin.
- Fix the bottom door holder onto the left side using the screws (2 pieces) and the adjustable foot as well as screw the 2 pieces screws on the opposite side into the vacant holes. Be careful that the door edge of the refrigerator is parallel with the edge of the mantle.
- Put over the handle on the opposite side and cover up the vacant holes with the plastic nails from the bag of instruction book.
- After released the screws the adaptation of the doors can be adjusted with the horizontal control of central door holder.
- Put the appliance to its place, set it level and connect to the electricity supply.

In case you do not want to perform the procedures above, call the nearest brand-mark service. Technicians will accomplish the refitting expertly for charge.

### Important

After completion of the door reversing operation, check that the door gasket adheres to the cabinet. If the ambient temperature is cold (i.e. in Winter), the gasket may not fit perfectly to the cabinet. In that case, wait for the natural fitting of the gasket or accelerate this process by heating the part involved with a normal hairdryer on a low setting.

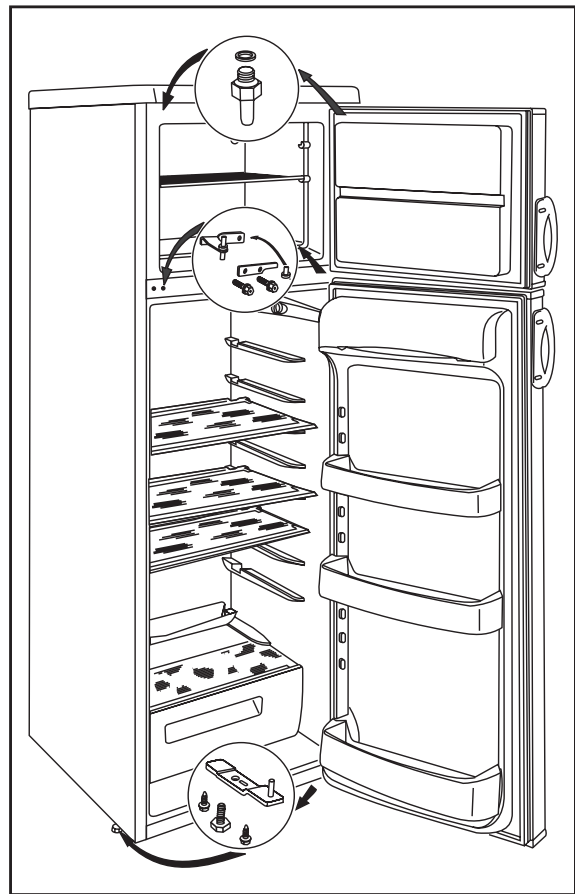

# Electrical Connection

 Any electrical work required to install this appliance should be carried out by a qualified electrician or competent person.

*This appliance must be earthed.*

**The manufacturer declines any liability should these safety measures not be observed.**

## Electrical Requirements

Before switching on, make sure the electricity supply voltage is the same as that indicated on the appliance rating plate.

The appliance is supplied with a 13 amp plug fitted. In the event of having to change the fuse in the plug supplied, a 13 amp ASTA approved (BS 1362) fuse must be used. Should the plug need to be replaced for any reason. The wires in the mains lead are coloured in accordance with the following code:

Green and Yellow:	Earth
Blue:	Neutral
Brown:	Live

The wire coloured green and yellow must be connected to the terminal marked with the letter „E“ or by the earth symbol  or coloured green and yellow.

The wire coloured blue must be connected to the terminal „N“ or coloured black.

The wire coloured brown must be connected to the terminal marked „L“ or coloured red.

Upon completion there must be no cut, or stray strands of wire present and the cord clamp must be secure over the outer sheath.

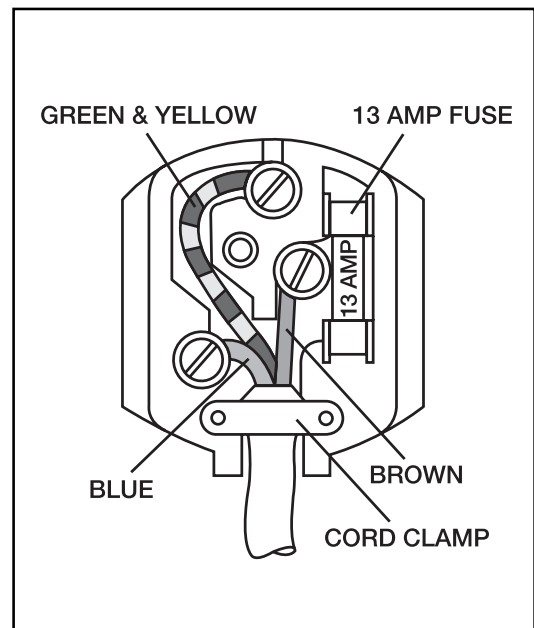

 This appliance complies with the following E.E.C. Directives:

- **73/23 EEC** of 19.02.73 (Low Voltage Directive) and subsequent modifications,
- **89/336 EEC** of 03.05.89 (Electromagnetic Compatibility Directive) and subsequent modifications.

# Storage time chart

Time and method of storage of fresh foods in the refrigerator

Foods	Storage time in days							Method of packaging
	1	2	3	4	5	6	7	
Raw meat	X	X	x	x	x			cling film, airtight
Cooked meat	X	X	X	x	x	x		dish covered
Roasted meat	X	X	X	x	x			dish covered
Raw minced meat	X							dish covered
Cooked minced meat	X	X	x	x				dish covered
Cold cuts	X	X	x	x				cling film, cellophane, grease-proof paper
Fresh fish	X	x	x					cling film, airtight
Cooked fish	X	X	x	x				dish covered
Tinned fish, open	X	x	x					dish covered
Fresh chicken	X	X	X	x	x	x		cling film, airtight
Fried chicken	X	X	X	x	x	x		dish covered
Fresh duck, goose	X	X	X	x	x	x		cling film, airtight
Roasted duck, goose	X	X	X	X	x	x	x	dish covered
Butter unopened	X	X	X	X	X	X	X	original packaging
Butter opened	X	X	x	x	x	x	x	original packaging
Milk	X	X	X	x	x			original packaging
Cream	X	X	x	x				plastic box
Sour cream	X	X	X	X	x	x	x	plastic box
Cheese (hard)	X	X	X	X	X	X	X	aluminium foil
Cheese (soft)	X	X	X	X	x	x	x	cling film
Egg	X	X	X	X	X	X	X	
Spinach, sorrel	X	X	x	x				cling film
Green peas, green beans	X	X	X	X	x	x	x	cling film
Mushroom	X	X	x	x	x			cling film
Carrot	X	X	X	X	X	X	X	cling film
Tomato	X	X	X	X	X	X	X	cling film
Cabbage	X	X	X	X	X	x	x	cling film
Fruits (Strawberry, raspberry, etc.)	X	X	X	x	x			cling film
Tinned fruits opened	X	X	X	x	x			dish covered
Cakes filled with cream	X	X	x	x				dish covered

## Notation:

- X** recommended storage time
- x** maximum recommended storage time

© Electrolux plc 2004

ELECTROLUX HOME PRODUCTS OPERATIONS EUROPE

 **From the Electrolux Group. The world's No.1 choice.**

*The Electrolux Group is the world's largest producer of powered appliances for kitchen, cleaning and outdoor use. More than 55 million Electrolux Group products (such as refrigerators, cookers, washing machines, vacuum cleaners, chain saws and lawn mowers) are sold each year to a value of approx. USD 14 billion in more than 150 countries around the world.*